

woodline

shade solutions

ASSEMBLY INSTRUCTIONS: 66LBS / 30KG CONCRETE BASE AND STAND

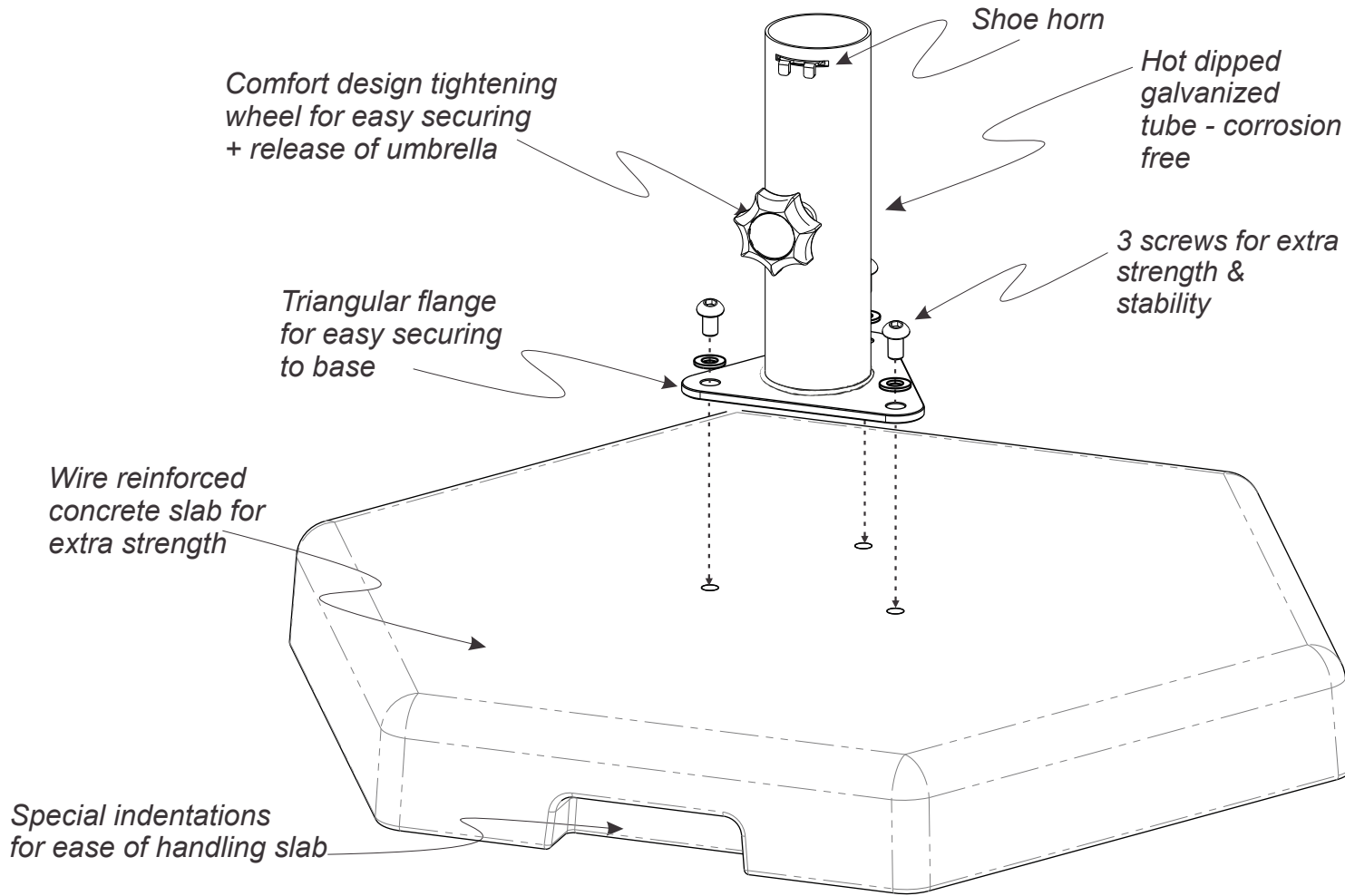

PACKED BY: _____ DATE: _____
 CHECKED BY: _____ DATE: _____

PARTS LIST

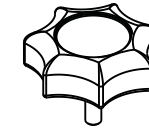

1 x FASTENING WHEEL

PACKED

1 x HOT DIPPED GALVANIZED METAL STAND

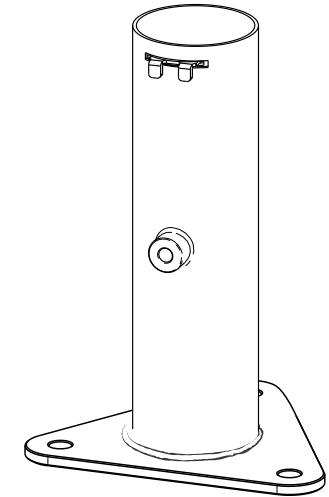

PACKED

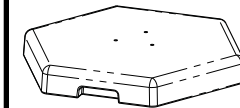

1 x REINFORCED CONCRETE SLAB

PACKED

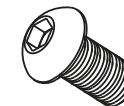

3 x M8 x 16 BUTTON HEAD SCREWS

PACKED



3 x M8 WASHERS

PACKED

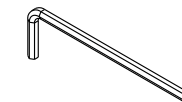

1 x 5mm ALLEN KEY

PACKED

woodline

shade solutions

For alternative base options
please view our website
www.woodlineshade.com

STEP 1

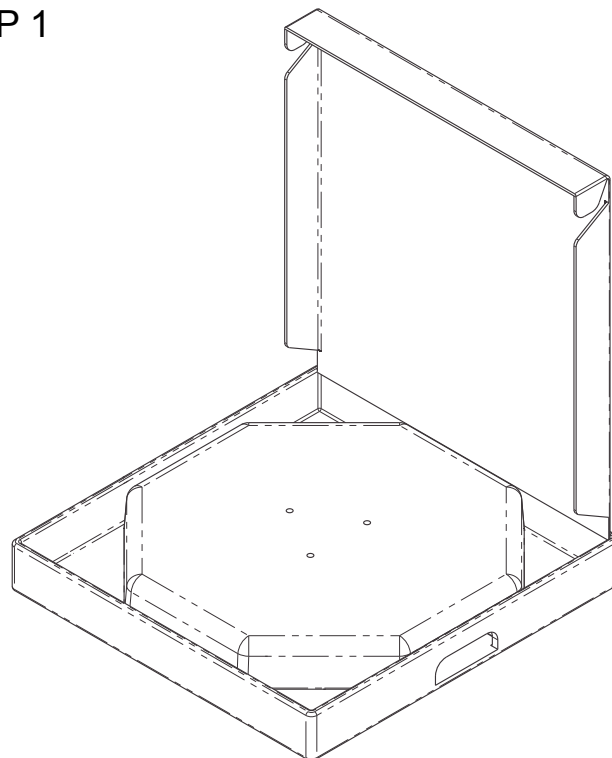

Open the flat square packaging box containing the concrete base.

STEP 2

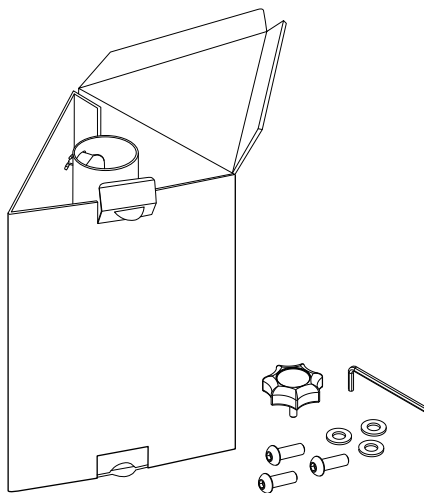

Open triangular box packaging containing the triangular galvanised metal stand, plus the allen key, fastening wheel, 3 x washers and 3 x screws in a ziploc bag.

STEP 3

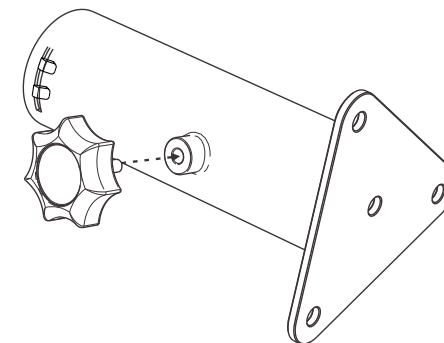

Attach the fastening wheel as illustrated above.

STEP 4

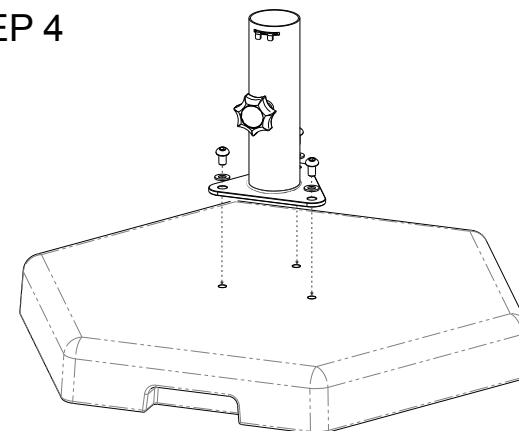

Secure the 3 x screws, washers and metal stand to base.

STEP 5

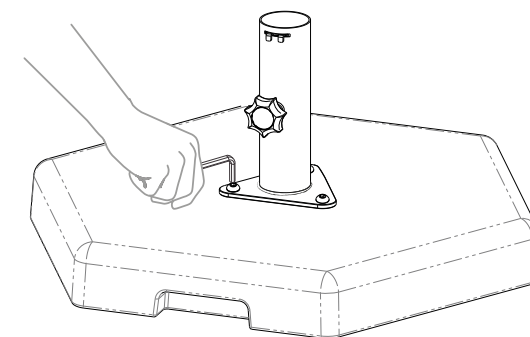

Use supplied allen key to ensure that all 3 screws are fastened tightly.
NOTE: The fastening wheel will need to be loosened when inserting the umbrella pole into the base.